

Customer Approved
Date:

Part No.:
LL950S1C-A01T1

DATA SHEET

Issue Date: 2019.07.02

Issue No.: LTD-950-001

REVISION: V3

Designer	Checker	Approver
<i>Lisa</i>	<i>Rock</i>	<i>Allen</i>

SMD Type ■ Top view 9521 Package
LL950S1C-A01T1

Features

- 9521 package
- Top view LED
- High luminous flux output
- Compatible with infrared and vapor phase reflow solder process
- Pb-free
- RoHS compliant



Package Dimensions

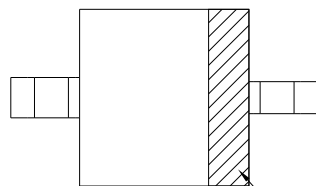
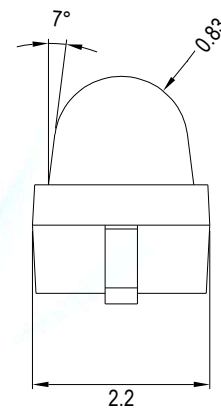
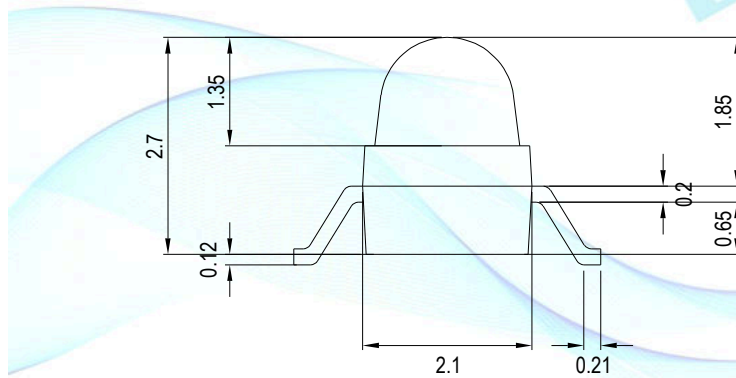
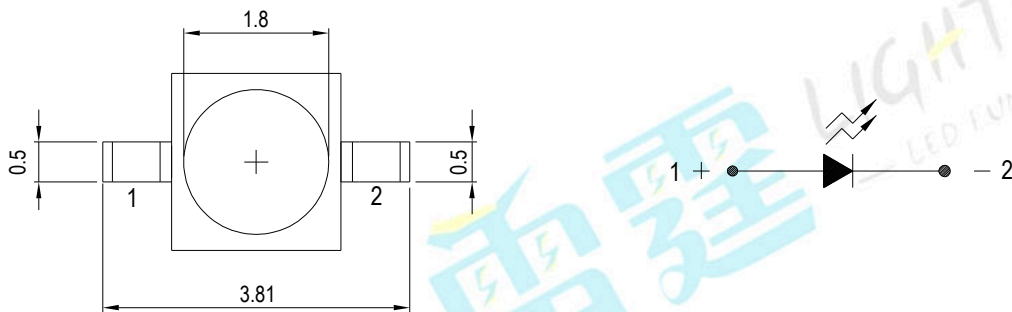

Cathode Mark

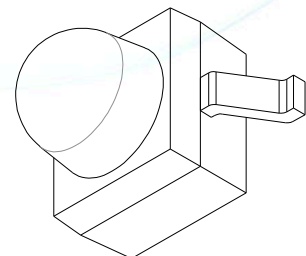

Note:
Tolerance unless mentioned is ± 0.1 mm, Unit = mm.

Applications

- General lighting
- Decorative and Entertainment Lighting
- Indicators
- Illumination
- Automotive Telecommunication
- Switch lights

Device Selection Guide

Emitted Color	Resin Color
Orange	Water Clear

Absolute Maximum Ratings (T_{Soldering}=25°C)

Parameter	Symbol	Rating	Unit
Forward Current	I _F	20	mA
Peak Forward Current (T=1ms, tp=0.1ms)	I _{FP}	100	mA
Power Dissipation	P _d	50	mW
Operating Temperature	T _{opr}	-40 ~ +85	°C
Storage Temperature	T _{stg}	-40 ~ +85	°C
Soldering Temperature	T _{sol}	Reflow Soldering : 260 °C for 10 sec. Hand Soldering : 350 °C for 3 sec.	
Reverse Voltage	V _R	5	V

Electro-Optical Characteristics (T_{Soldering}=25°C)

Parameter	Symbol	Min.	Typ.	Max.	Unit	Condition
Luminous Intensity	I _v	317	715	--	mcd	I _F =20mA
Forward Voltage	V _F	--	2.0	2.6	V	I _F =20mA
Peak Wavelength	λ _p	--	611	--	nm	I _F =20mA
Dominant Wavelength	λ _D	600	--	610	nm	I _F =20mA
Viewing Angle	2θ _{1/2}	--	35	--	deg	I _F =20mA
Reverse Current	I _R	--	--	1	μA	V _R =5V

Notes:

1. Tolerance of Luminous Intensity: ±10%.
2. Tolerance of Dominant Wavelength : ±1nm.
3. Tolerance of Forward Voltage : ±0.1V.

Typical Electro-Optical Characteristics Curves

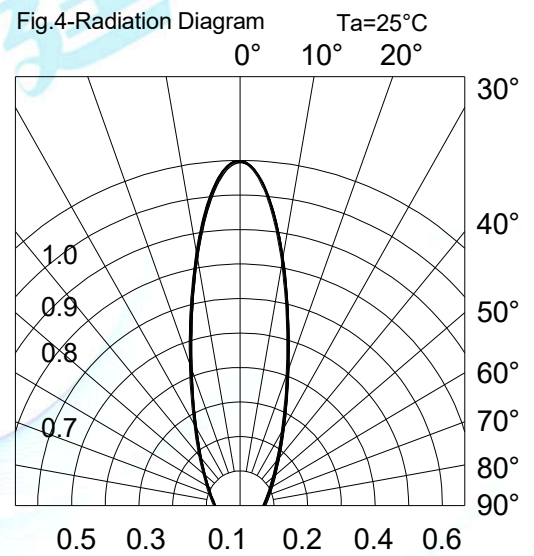
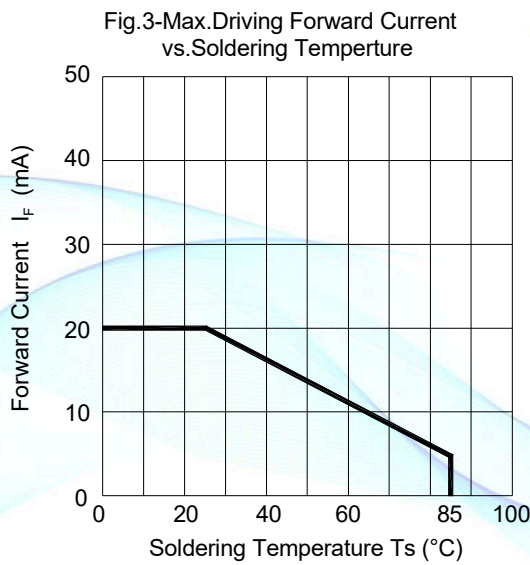
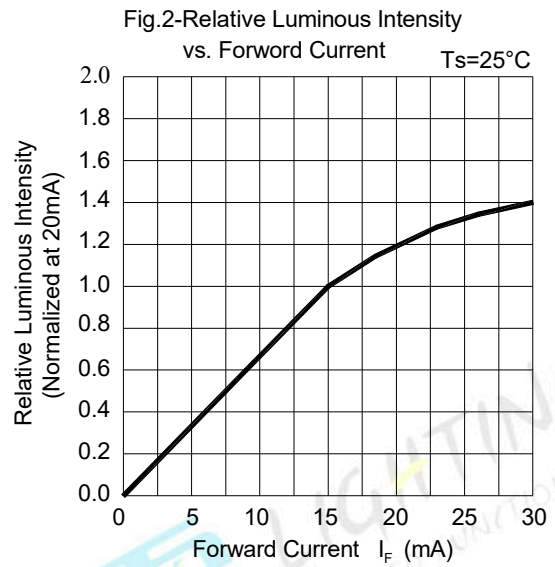
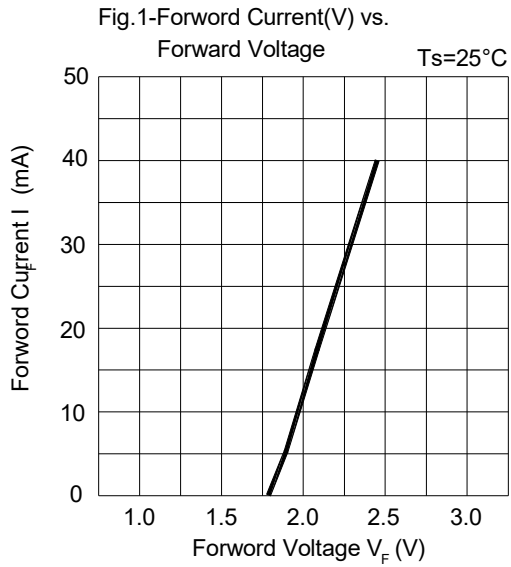

Typical Electro-Optical Characteristics Curves

Fig.5-Forward Voltage Shift vs. Junction Temperature

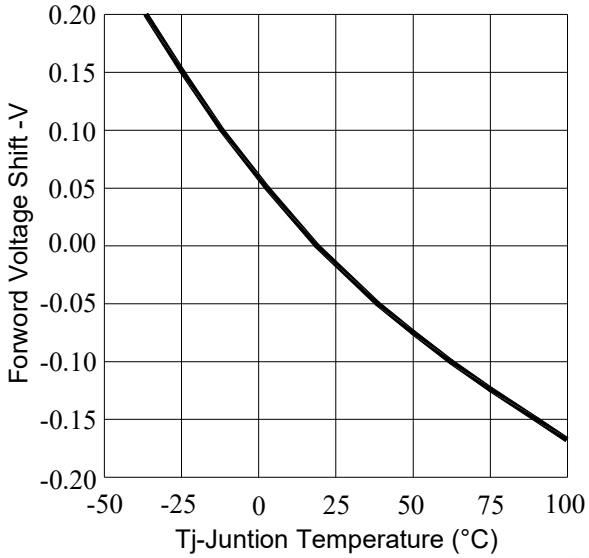
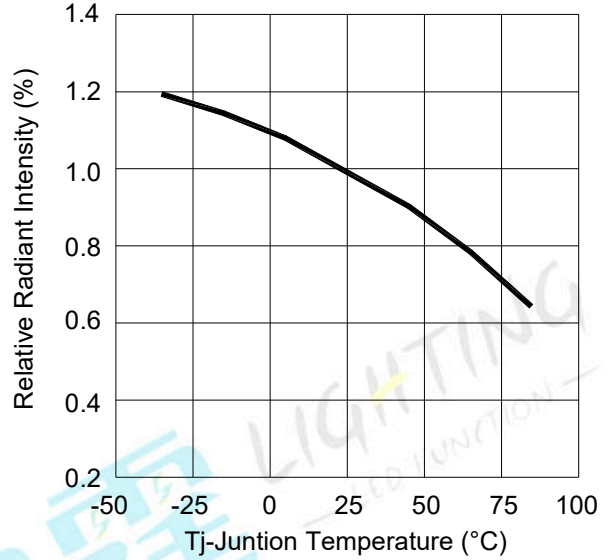
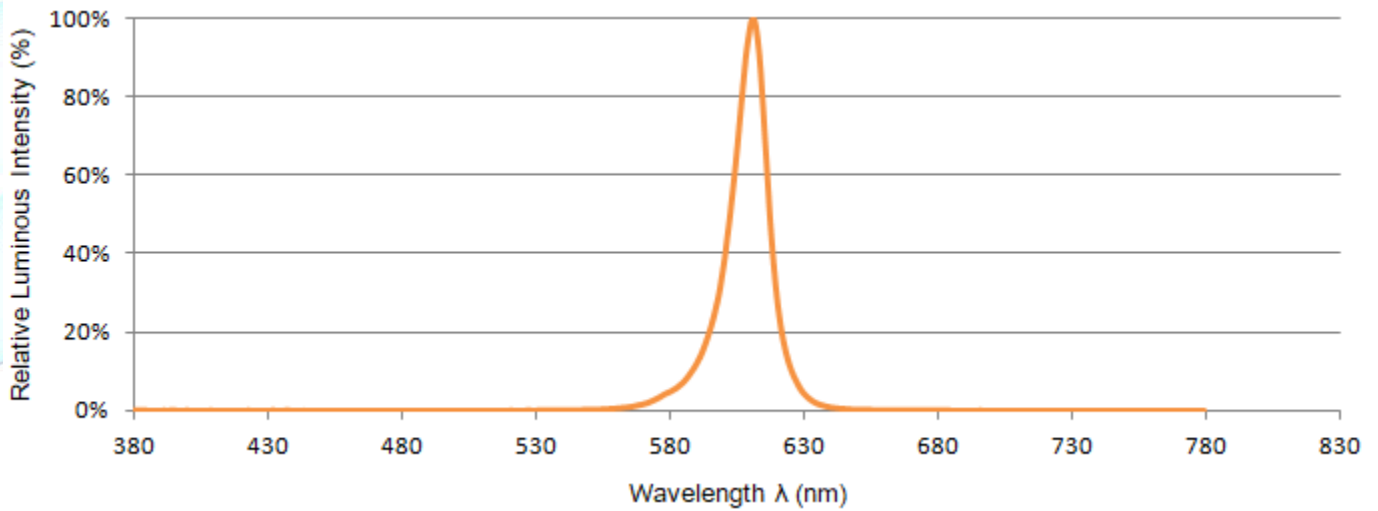

Fig.6-Relative Radiant Intensity vs. Junction Temperature



Spectrum Distribution



Moisture Resistant Packing Materials

Label Explanation



- * QR code:
Contains all of the following information
- * P/N: Product Number
- * TYPE :Part NO.
- * IV: Luminous Intensity
- * WD:Chromaticity Coordinates Rank
- * VF: Forward Voltage Rank
- * QTY: Packing Quantity
- * LOT NO.: Lot Number

Taping method: Loaded Quantity 1,000 pcs Per Reel

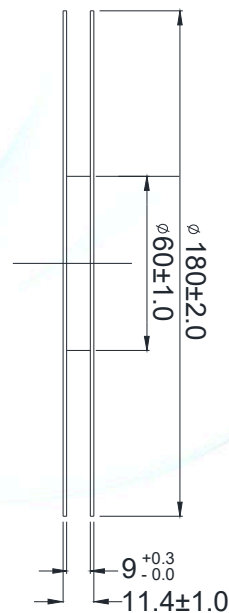
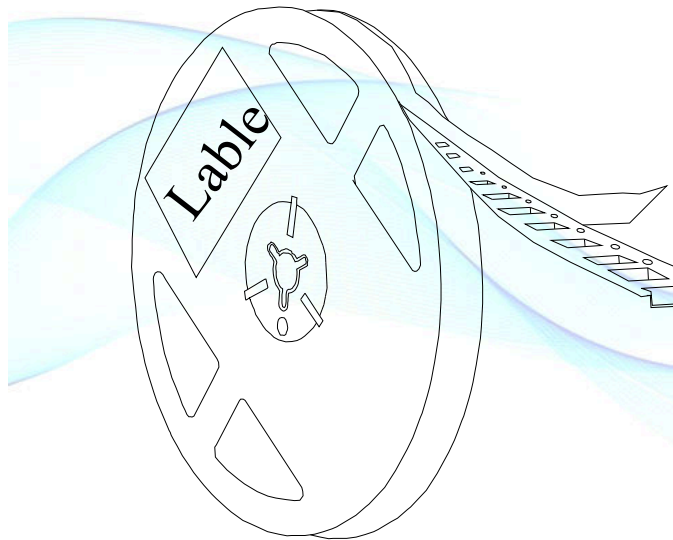

- Notes:
1. Tolerance unless mentioned is ± 0.1 mm, Unit = mm.
 2. Minimum packing amount is 500 pcs per reel.

Carrier Tape Dimensions:

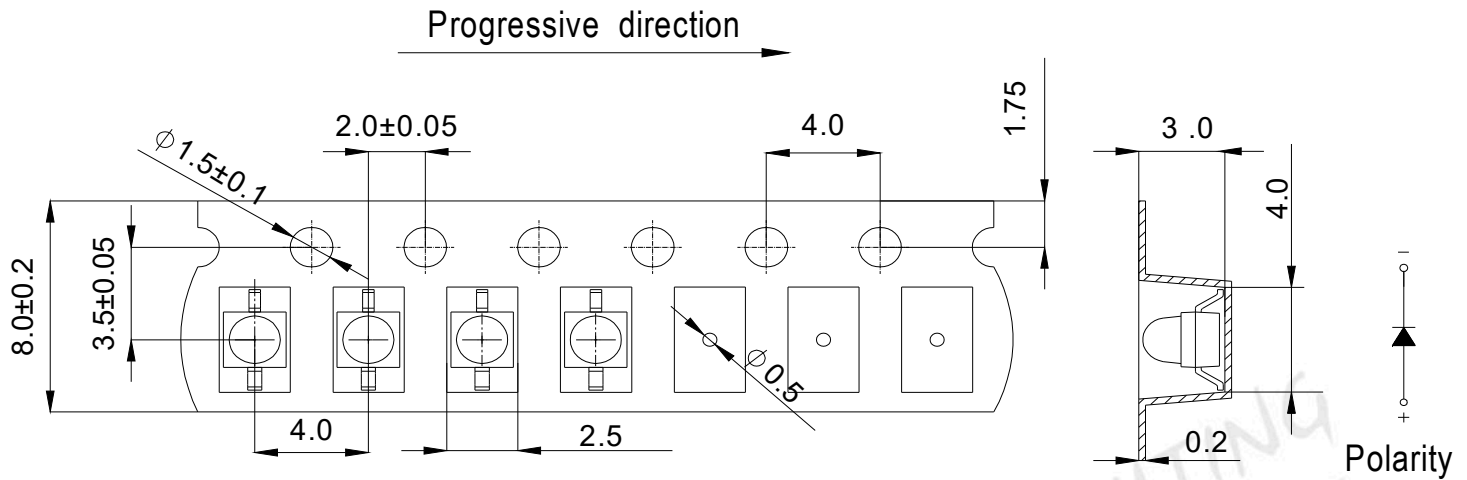

Note:
Tolerance unless mentioned is ±0.1mm, Unit = mm.

Moisture Resistant Packing Process

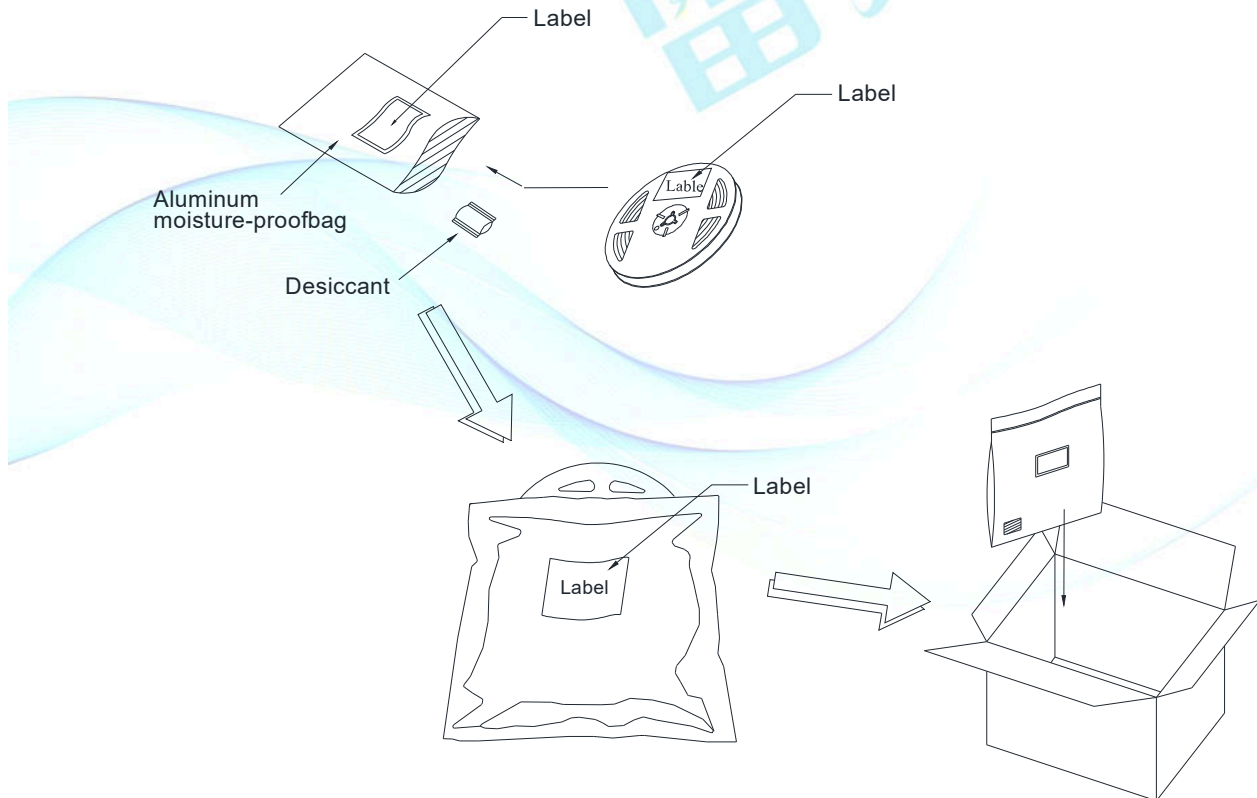

Moisture/Reflow sensitivity classification
IPC / JEDEC J-STD-020C: Level 3

Reliability Test Items and Conditions

The reliability of products shall be satisfied with items listed below.

Confidence level : 90%

LTPD : 10%

No.	Items	Test Condition	Test Hours/Cycles	Sample Size	Ac/Re
1	Reflow Soldering	Temp.: 260°C/10sec.	6 Min.	22 PCS.	0/1
2	Thermal Shock	H : +100°C/5min § 10 sec L : -10°C/5min	300 Cycles	22 PCS.	0/1
3	Temperature Cycle	H : +100°C/15min § 5 min L : -40°C/15min	300 Cycles	22 PCS.	0/1
4	High Temperature/Humidity Storage	Ta=85°C,85%RH	1000 Hrs.	22 PCS.	0/1
5	Low Temperature Storage	Ta=-40°C	1000 Hrs.	22 PCS.	0/1
6	High Temperature Storage	Ta=100°C	1000 Hrs.	22 PCS.	0/1
7	DC Operation Life	Ta=25°C, I _F = 20 mA	1000 Hrs.	22 PCS.	0/1

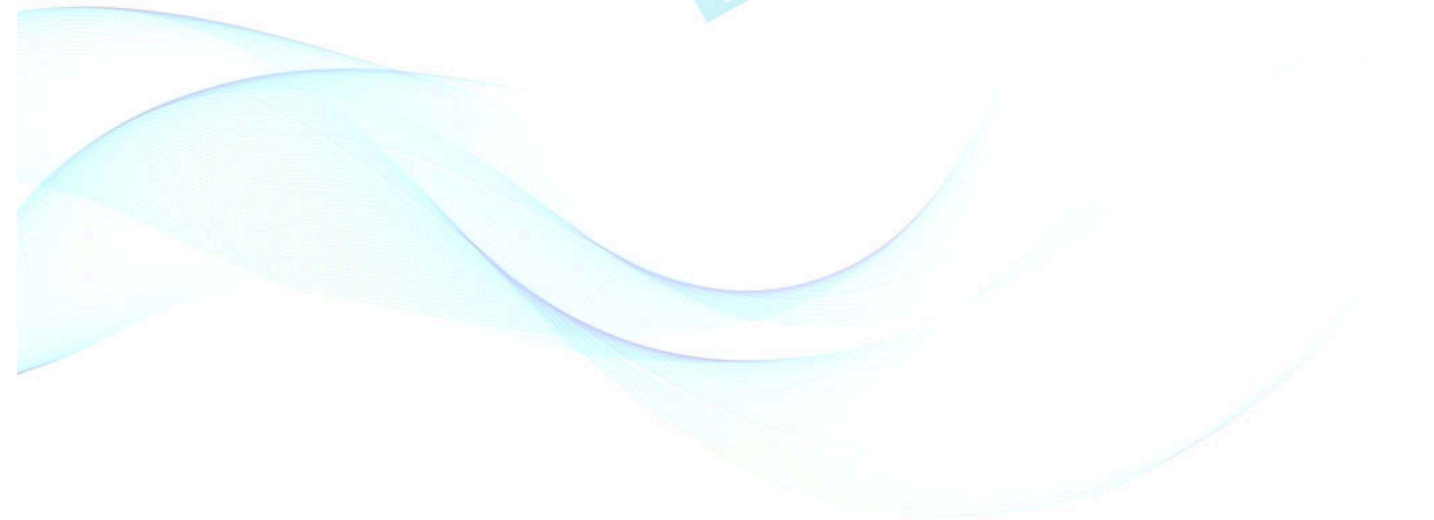

Precautions for Use

1. Over-current-proof

Customer must apply resistors for protection; otherwise slight voltage shift will cause big current change (Burn out will happen).

2. Storage

2.1 Do not open moisture proof bag before the products are ready to use.

2.2 Before opening the package: The LEDs should be kept at 30°C or less and 90%RH or less.

2.3 After opening the package: The LED's floor life is 168 hours under 30°C or less and 60%RH or less. If unused LEDs remain, it should be stored in moisture proof packages.

2.4 If the moisture absorbent material (silica gel) has faded away or the LEDs have exceeded the storage time, baking treatment should be performed using the following conditions.

Baking treatment: 60±5°C for 24 hours.

3. Soldering Condition

3.1 Pb-free solder temperature profile

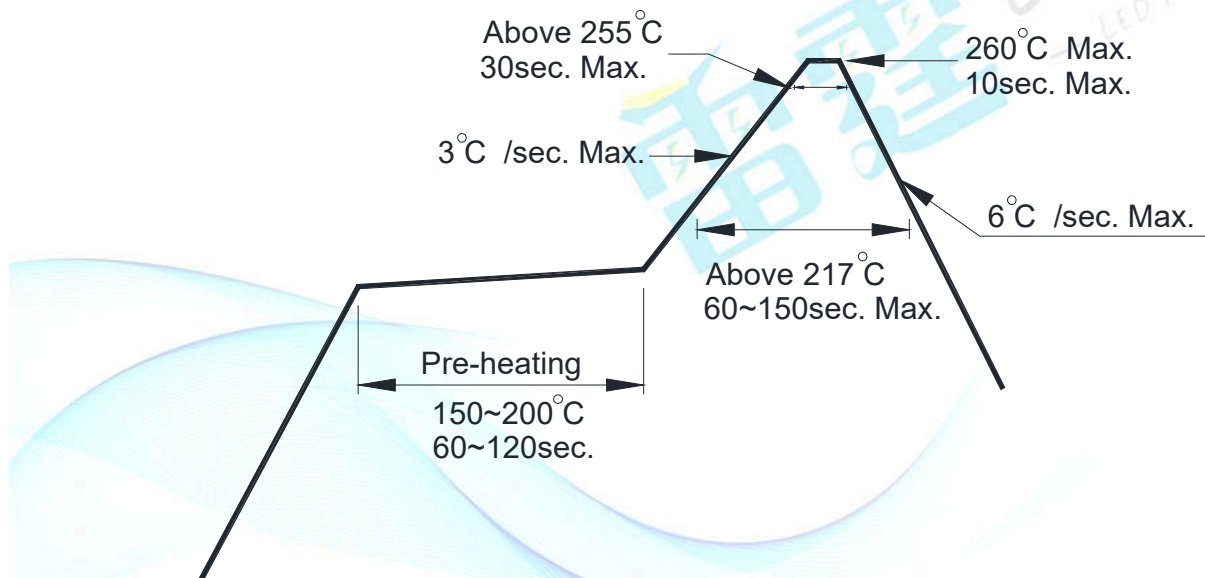

3.2 Reflow soldering should not be done more than two times.

3.3 When soldering, do not put stress on the LEDs during heating.

3.4 After soldering, do not warp the circuit board.

4. Soldering Iron

Each terminal is to go to the tip of soldering iron temperature less than 350°C for 3 seconds within once in less than the soldering iron capacity 25W. Leave two seconds and more intervals and do soldering of each terminal. Be careful because the damage of the product is often started at the time of the hand solder.

5. Repairing

Repair should not be done after the LEDs have been soldered. When repairing is unavoidable, a double-head soldering iron should be used (as below figure). It should be confirmed beforehand whether the characteristics of the LEDs will or will not be damaged by repairing.